

Varenummer: 20479B1830
Beskrivelse: E+G Sensor holder - GN 479-B18-30

Mål

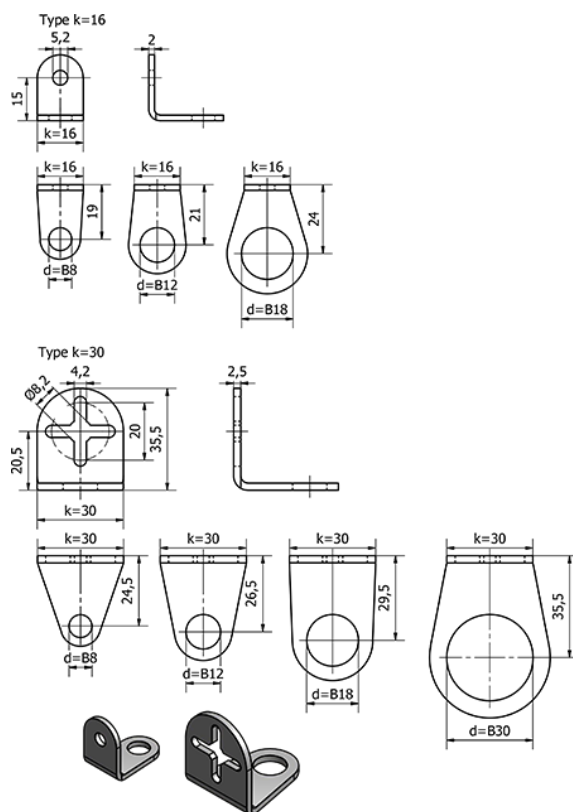

d = 18

k = 30

Vægt (g) = 30